

JADRIJA

REKONSTRUKCIJA KABINA
- FAKSIMILSKA OBNOVA -

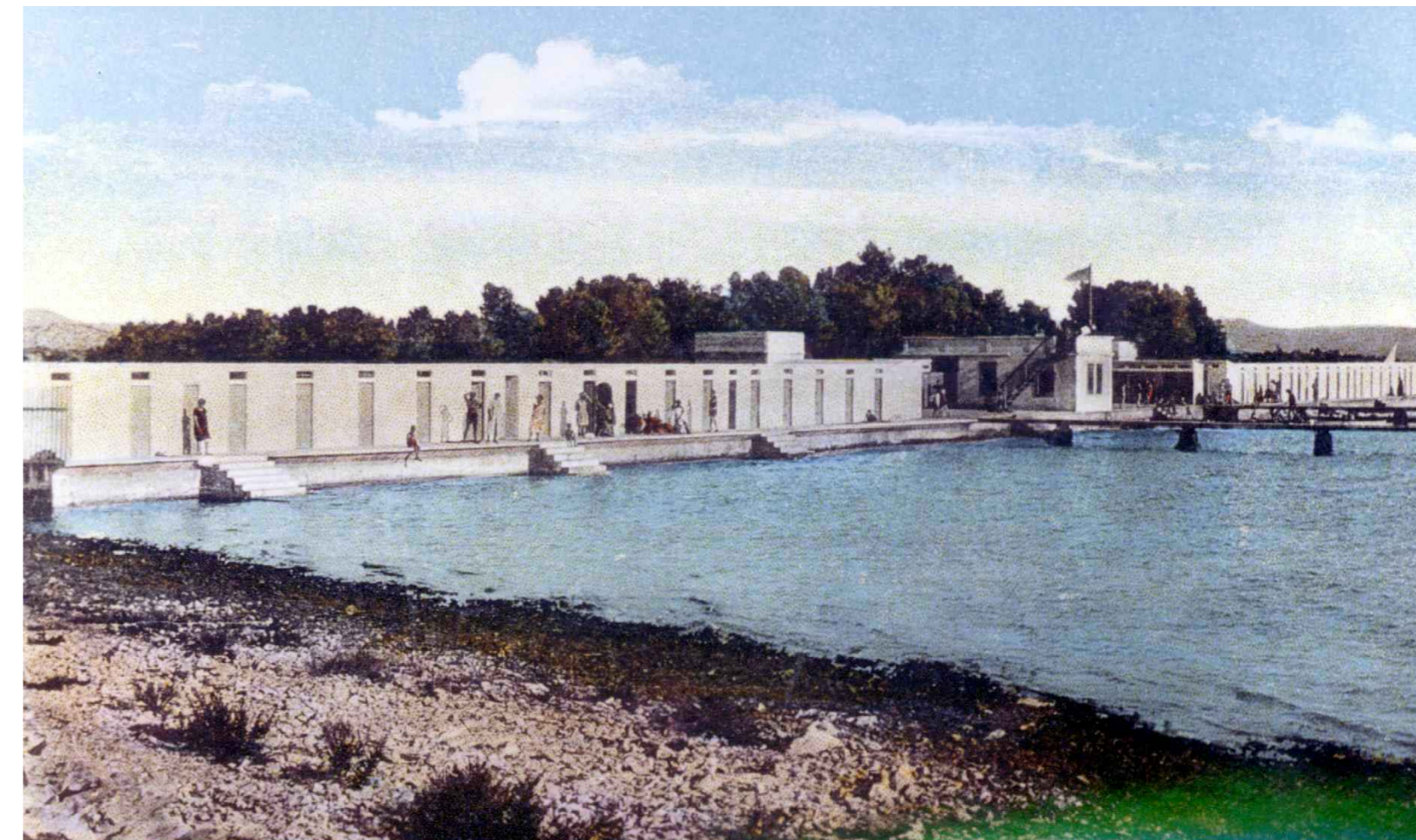

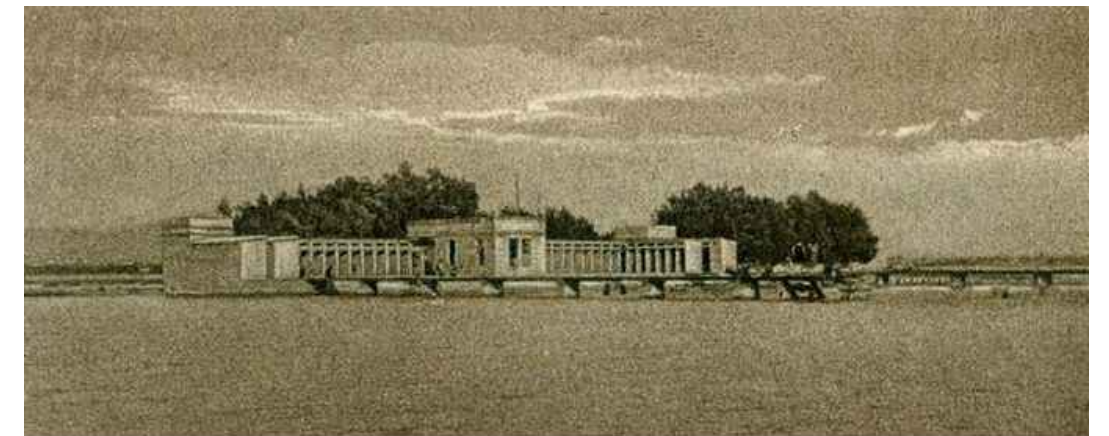

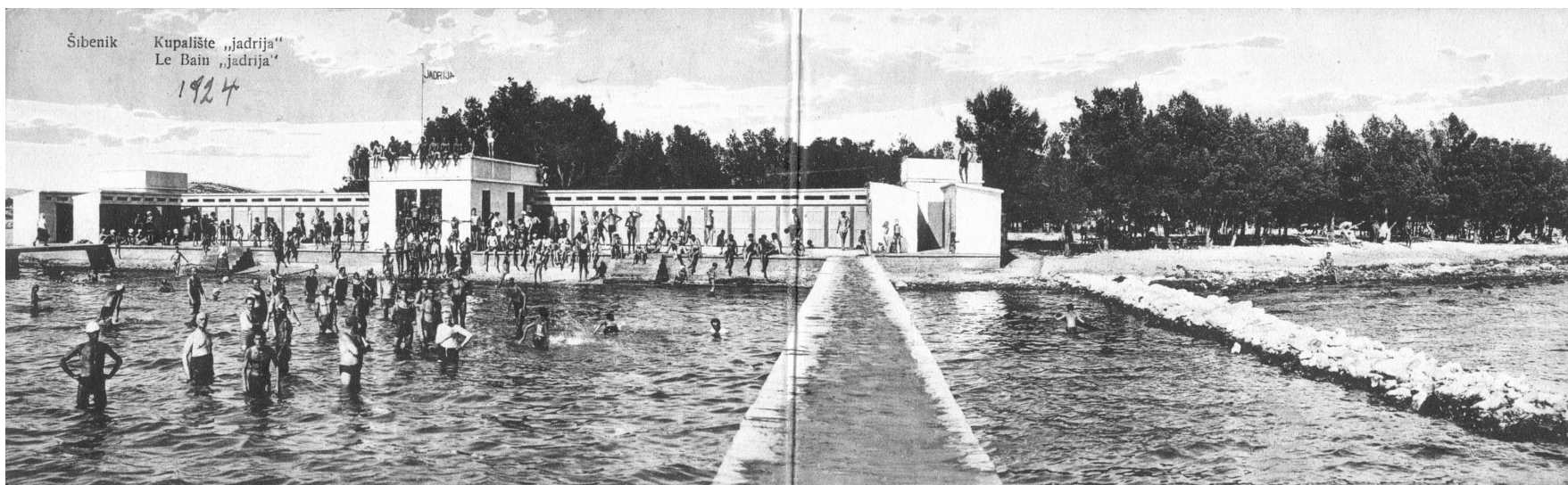
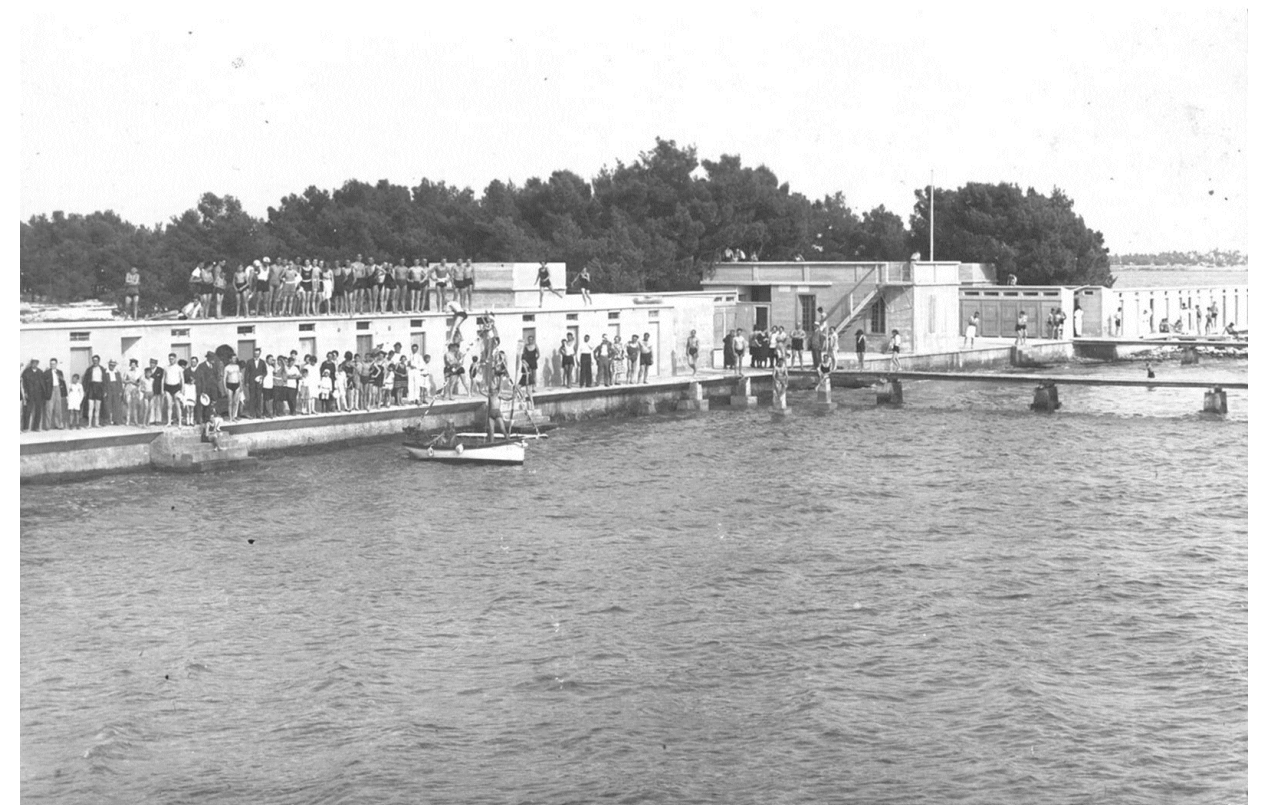
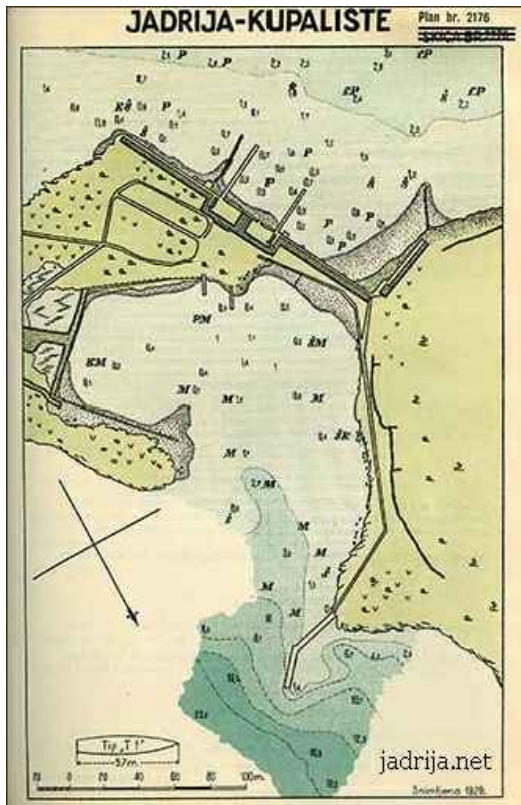
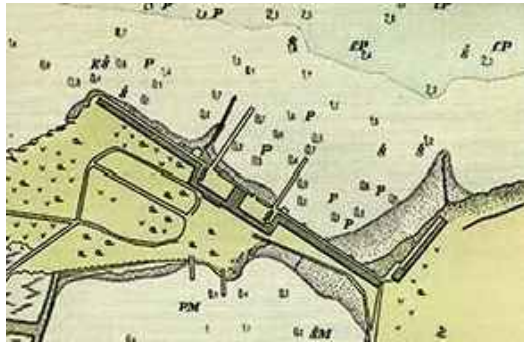
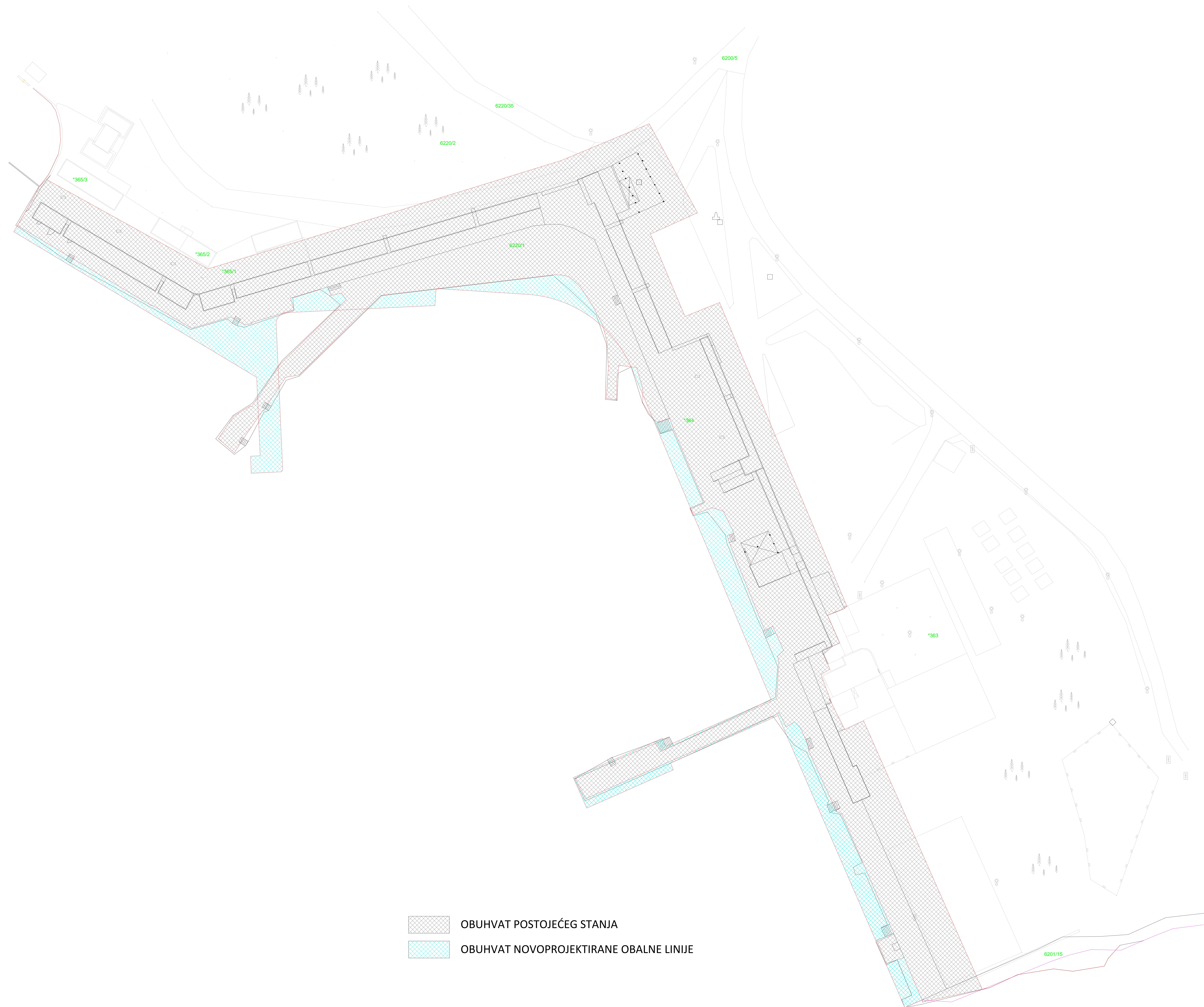

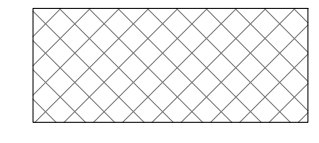
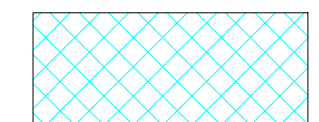
-  OBUHVAT POSTOJEĆEG STANJA
-  OBUHVAT NOVOPROJEKTIRANE OBALNE LINIJE

1. OBUHVAT NA GEODETSKOJ PODLOZI

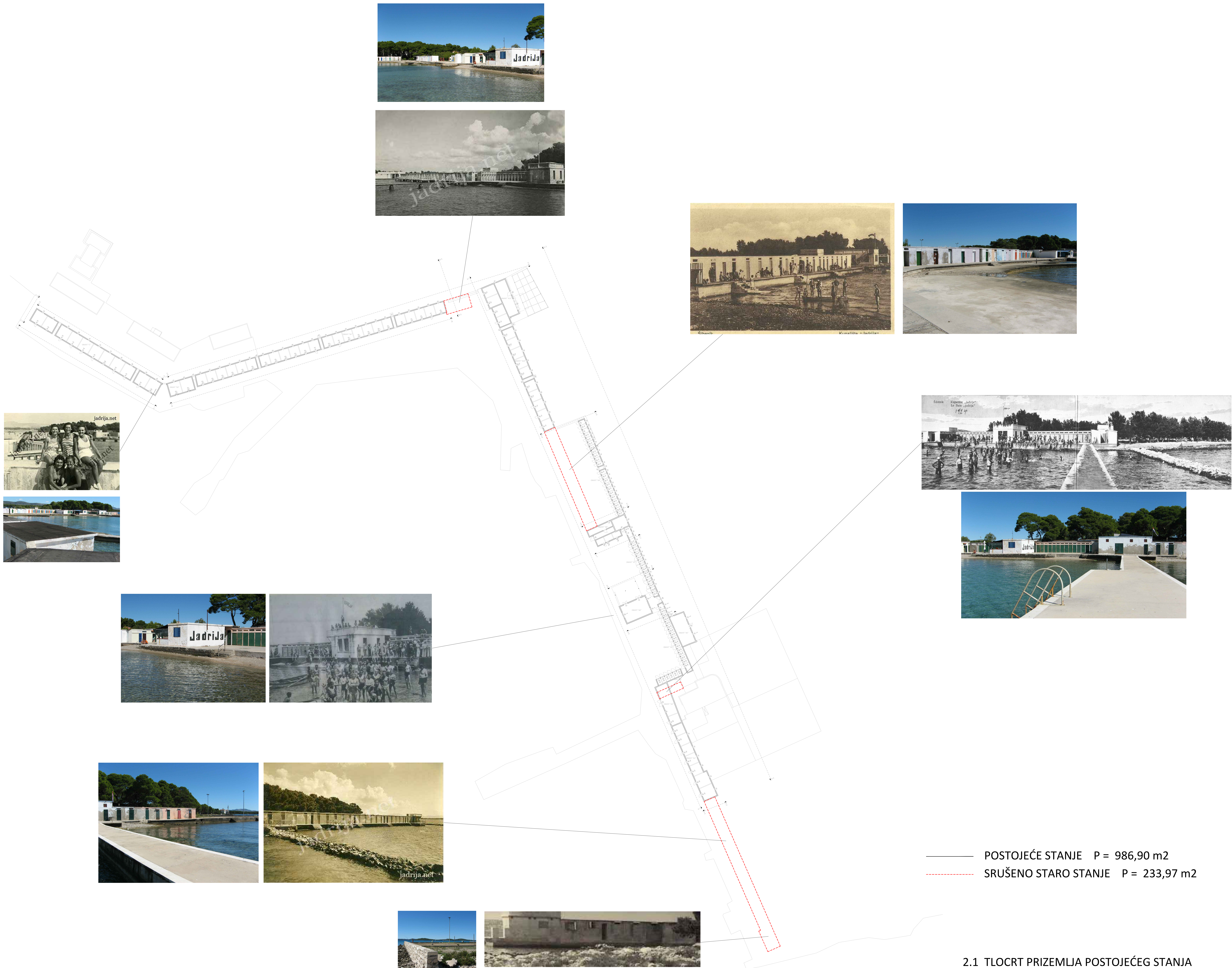

——— POSTOJEĆE STANJE P = 986,90 m²
 - - - - - SRUŠENO STARO STANJE P = 233,97 m²

2.1 TLOCRT PRIZEMLJA POSTOJEĆEG STANJA

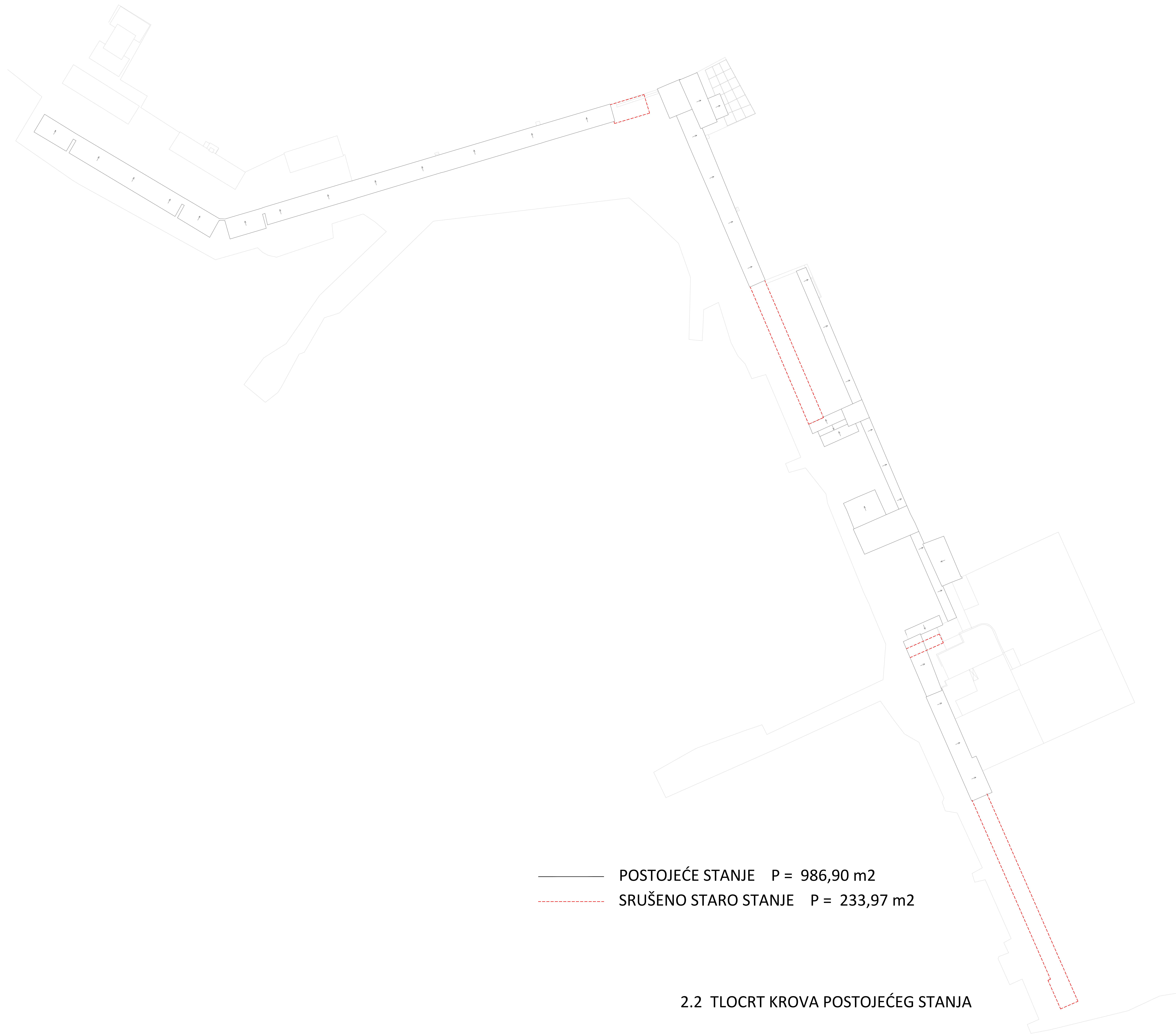

— POSTOJEĆE STANJE P = 986,90 m2
- - - SRUŠENO STARO STANJE P = 233,97 m2

2.2 TLOCRT KROVA POSTOJEĆEG STANJA



PROČELIE A-3

PROČELIE A-1

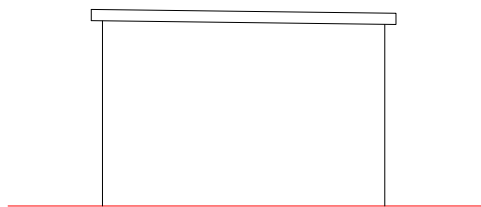

PROČELJE A-2

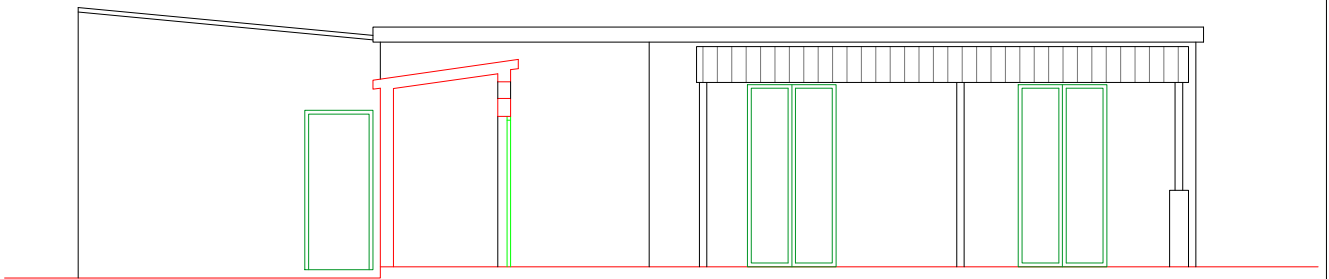

PROČELJE A-6

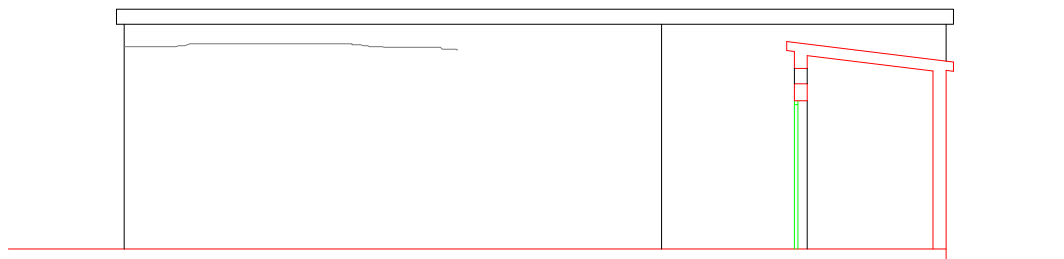

PROČELJE A-5

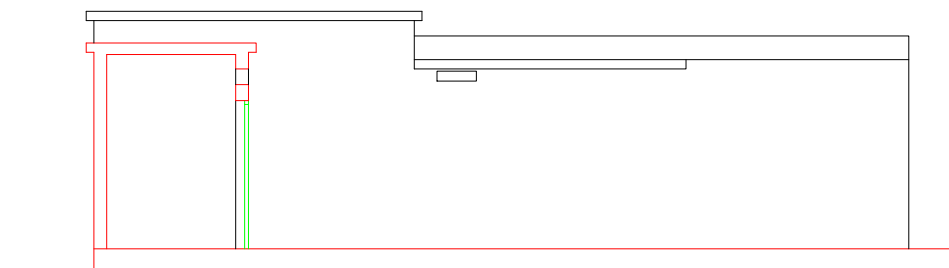

PROČELJE A-8

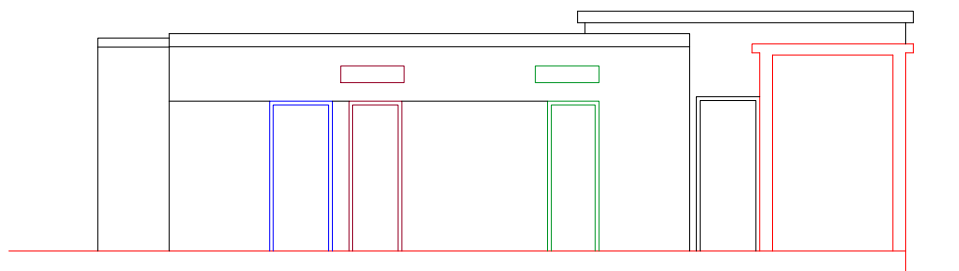

PROČELJE A-7

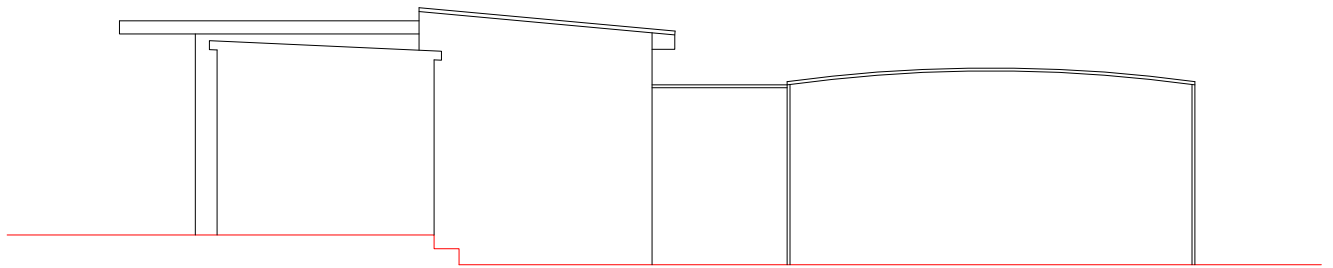

PROČELJE A-9

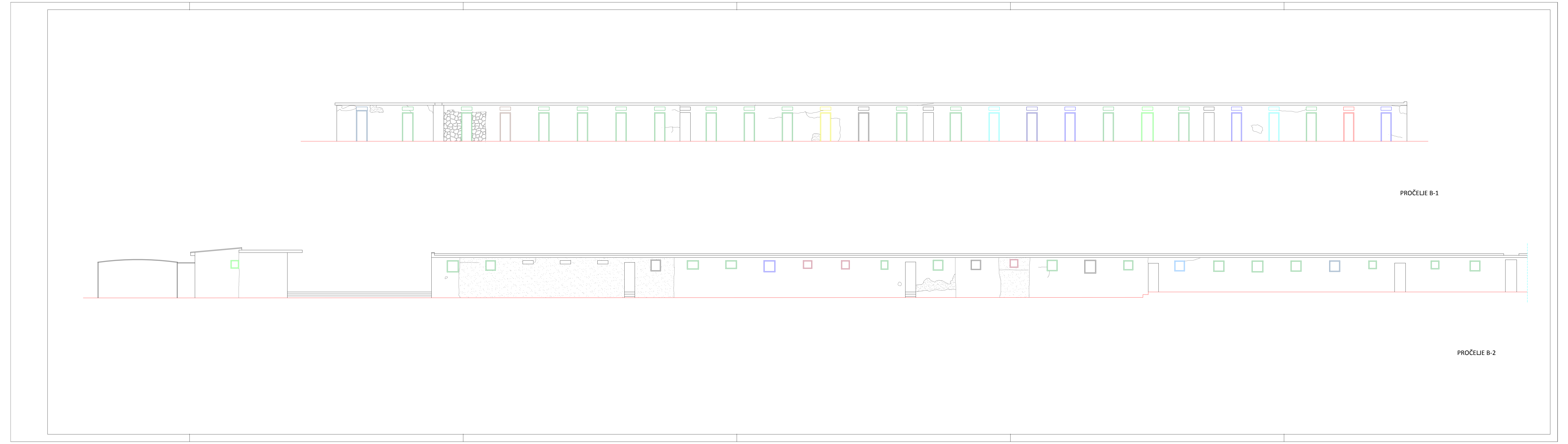



PROČELJE B-3

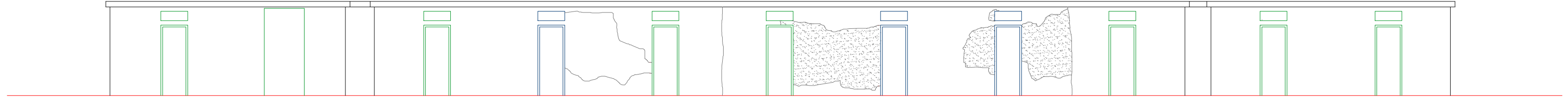

PROČELJE C-1

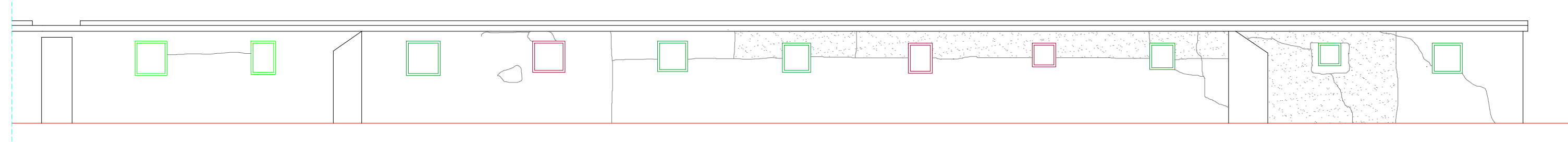

PROČELJE C-2

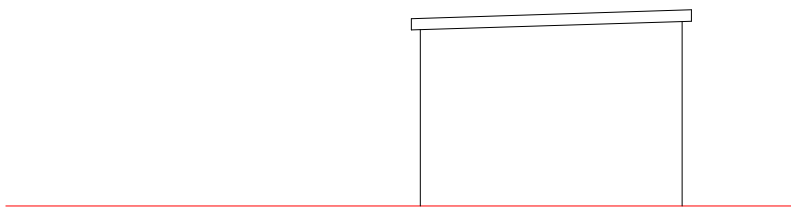

PROČELJE C-3



3.1 TLOCRT PRIZEMLJA NOVOPROJEKTIRANO STANJE



3.2 TLOCRT KROVA NOVOPROJEKTIRANO STANJE

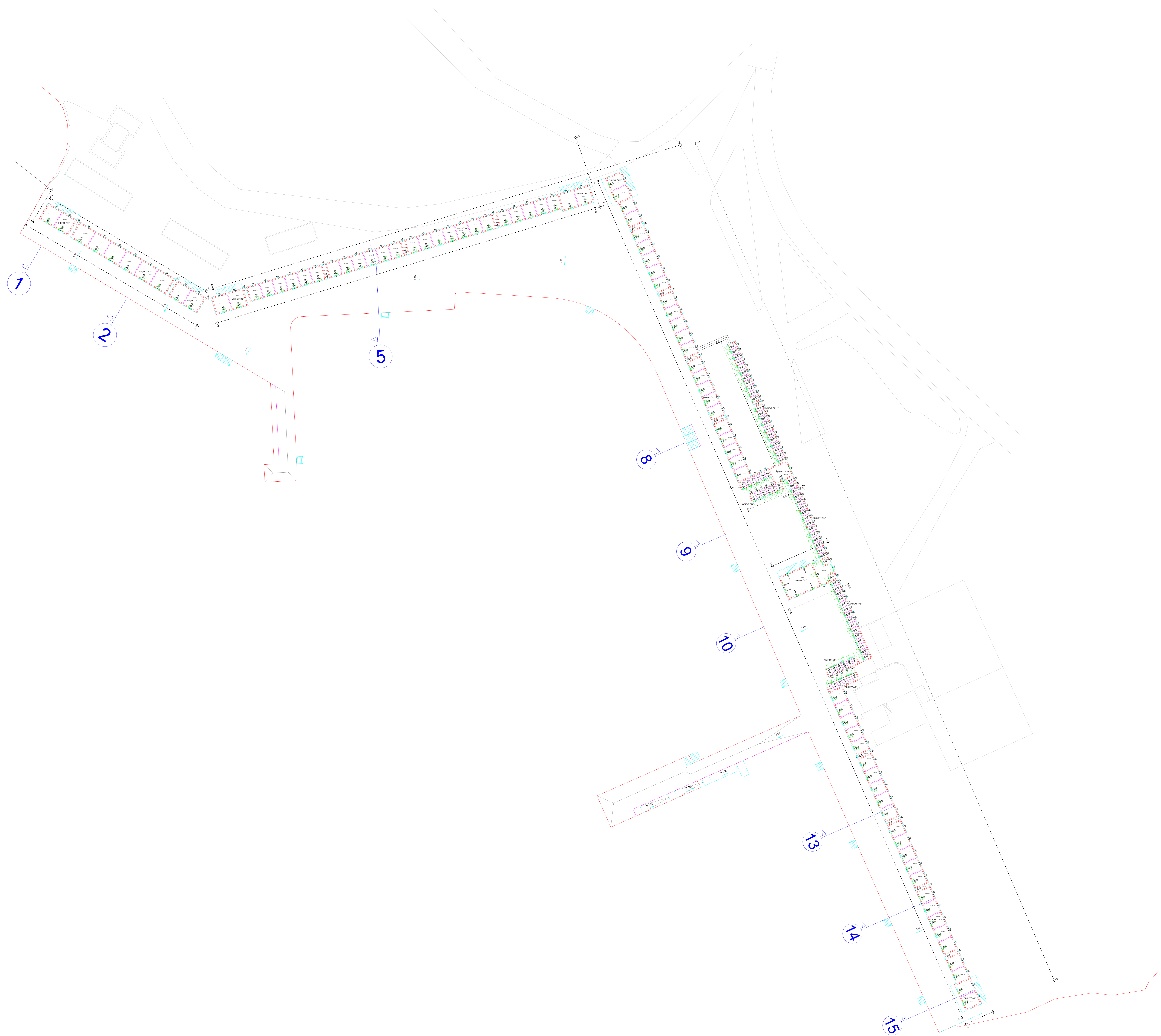

4.1 TLOCRT PRIZEMLJA NOVOPROJEKTIRANO STANJE

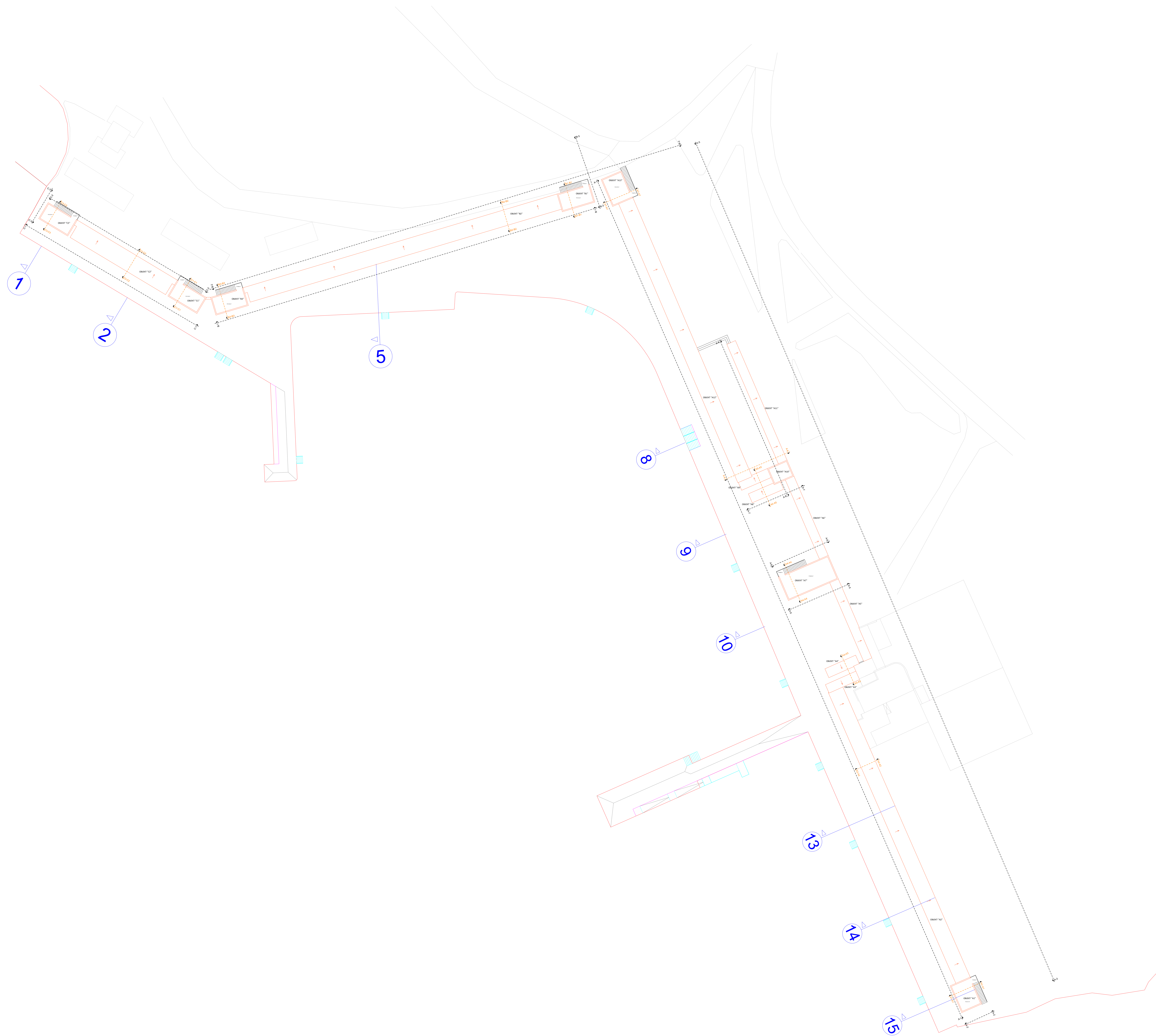

4.2 TLOCRT KROVA NOVOPROJEKTIRANO STANJE



PROČĚLIE A-3

PROČĚLIE A-1

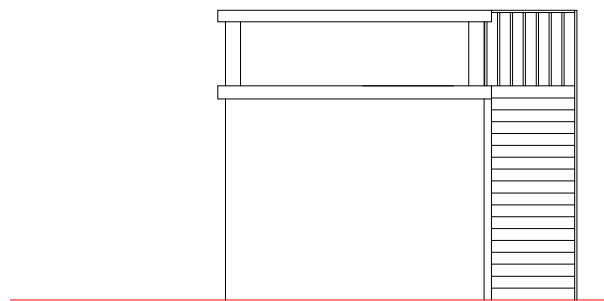

PROČELJE A-2

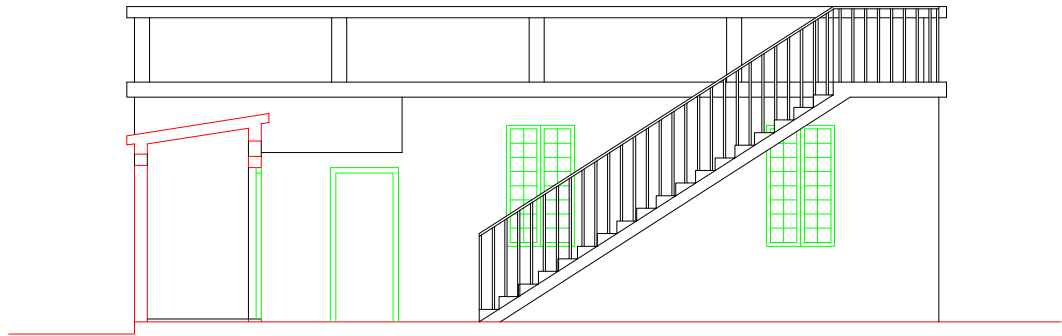

PROČELJE A-6

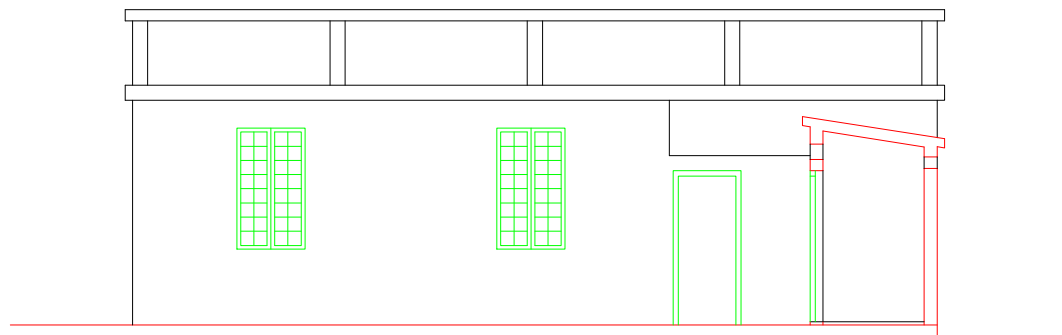

PROČELJE A-5

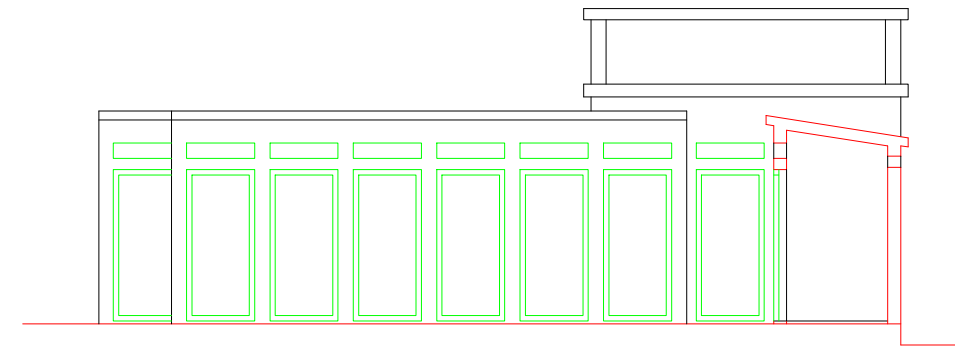

PROČELJE A-7

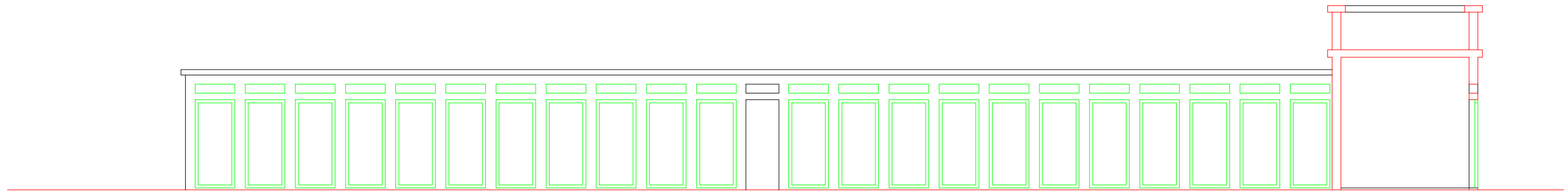

PROČELJE A-8

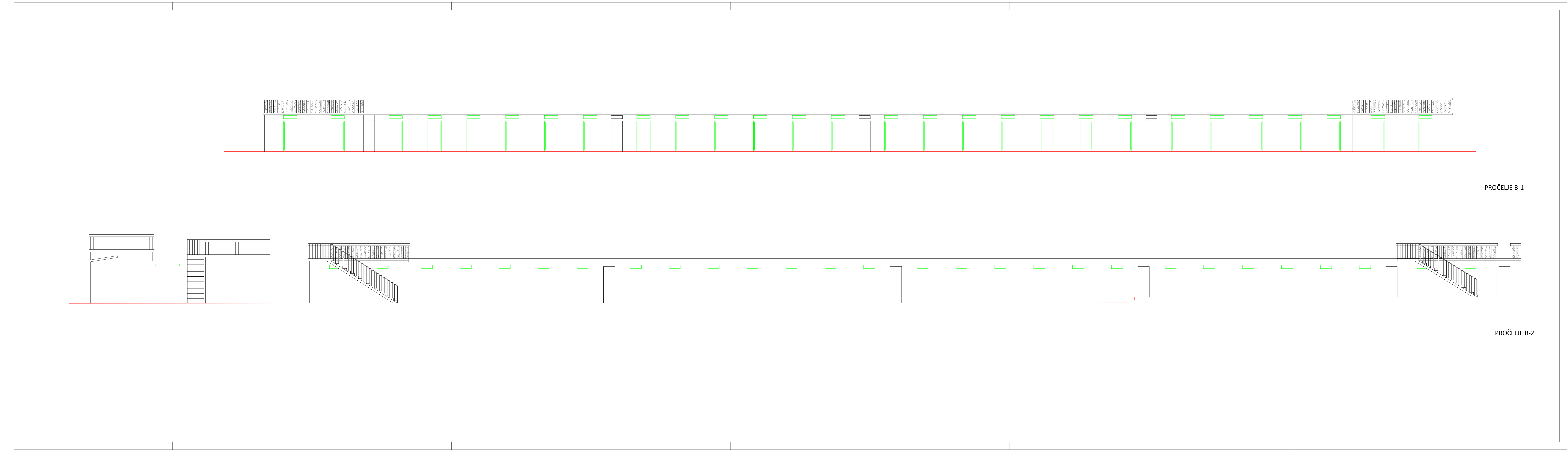

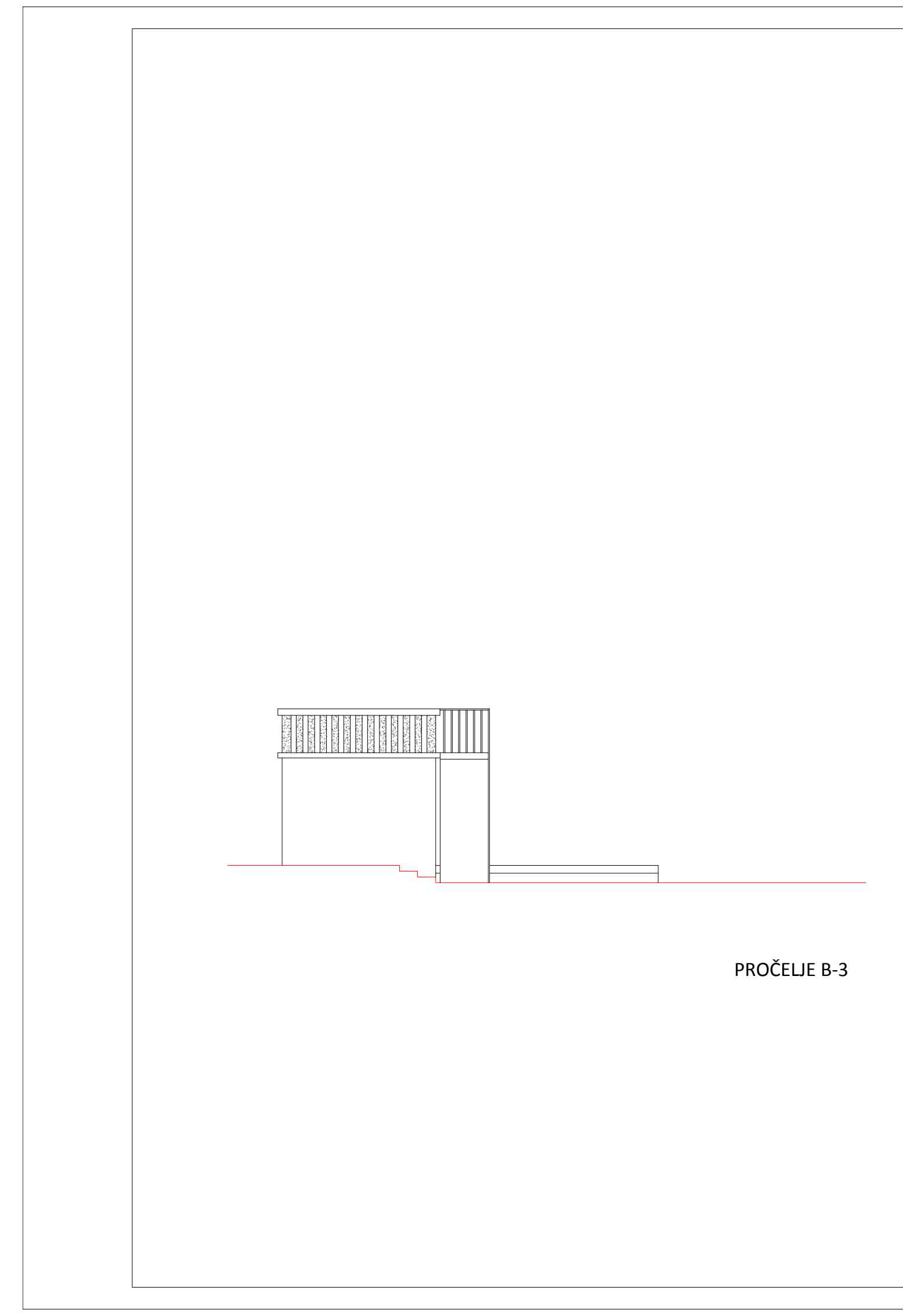

PROČELJE B-3

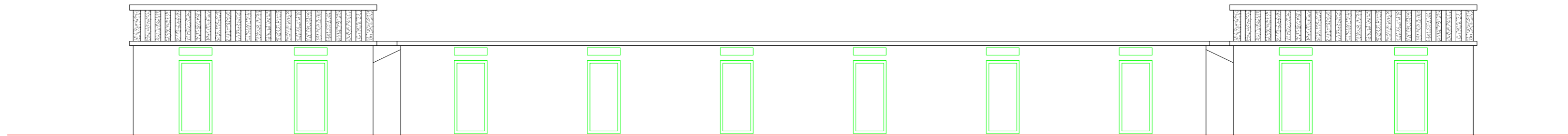

PROČELJE C-1



PROČELJE C-2

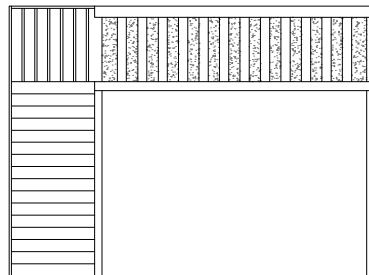

PROČELJE C-3

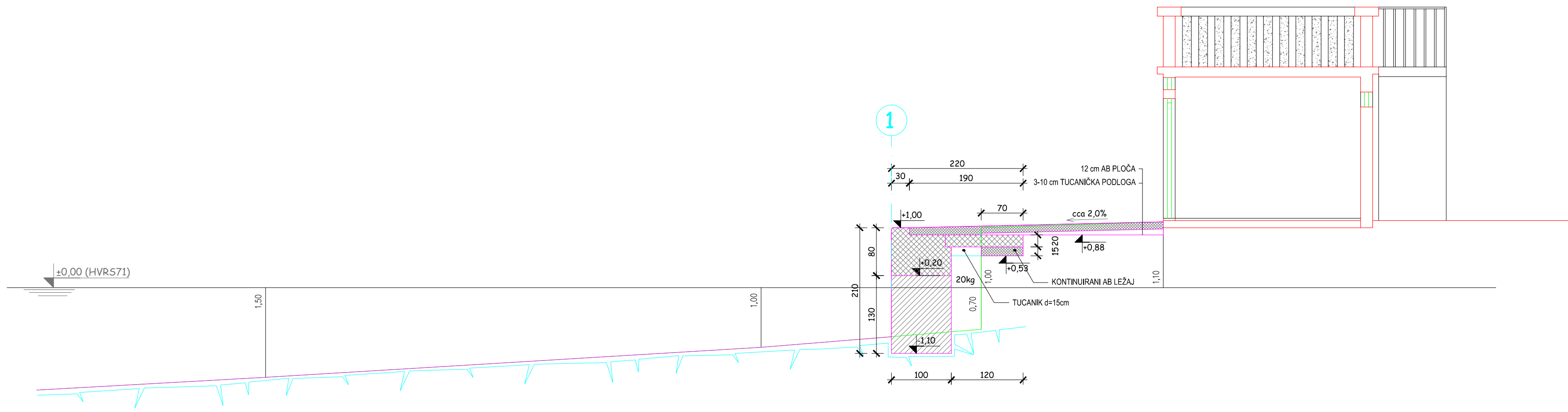

PRESJEK 1

mj 1:50

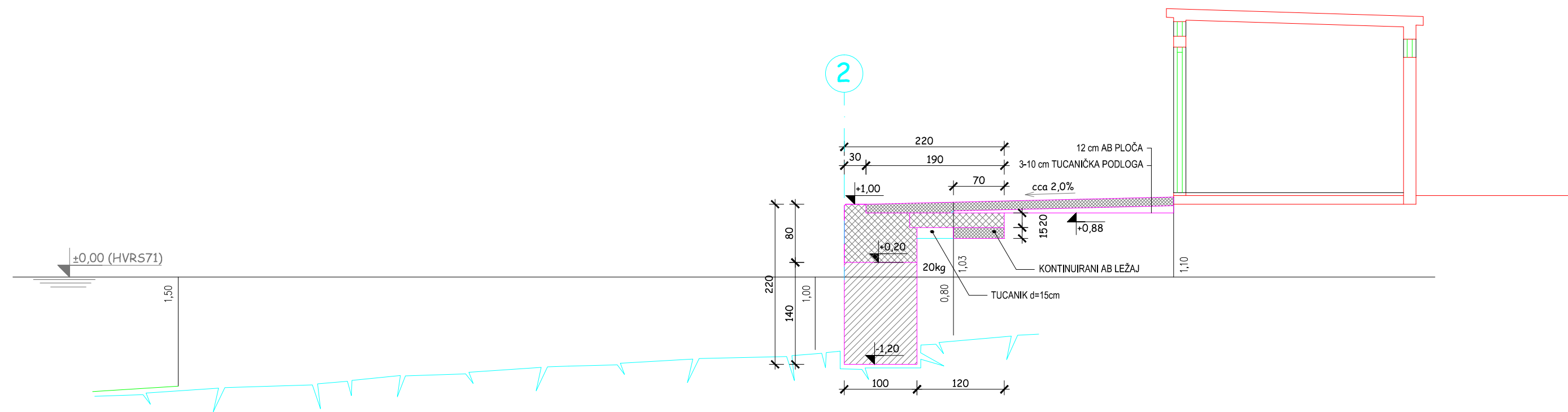

PRESJEK 2

mj 1:50

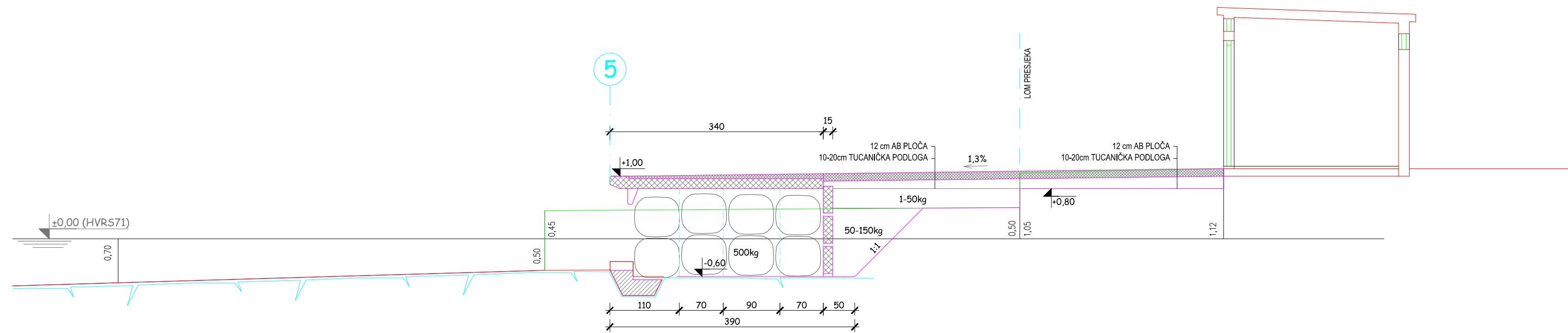

PRESJEK 5

mj 1:50

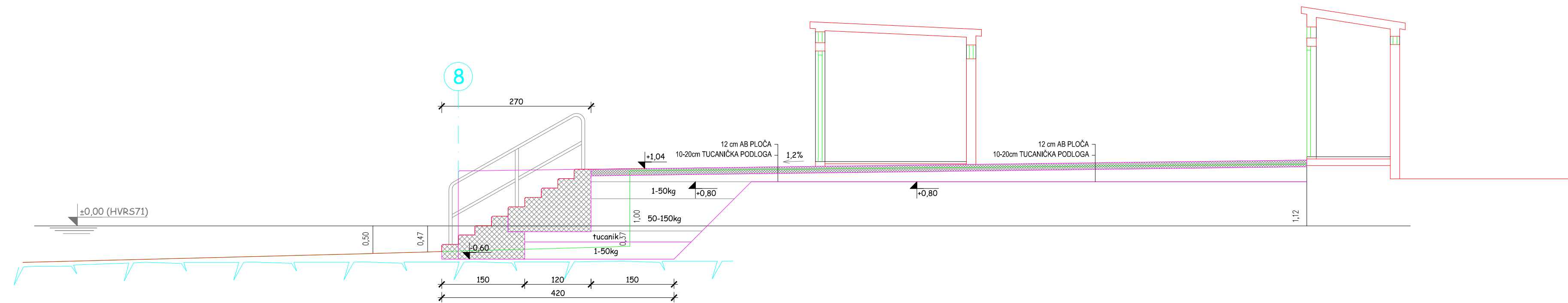

PRESJEK 8

mj 1:50

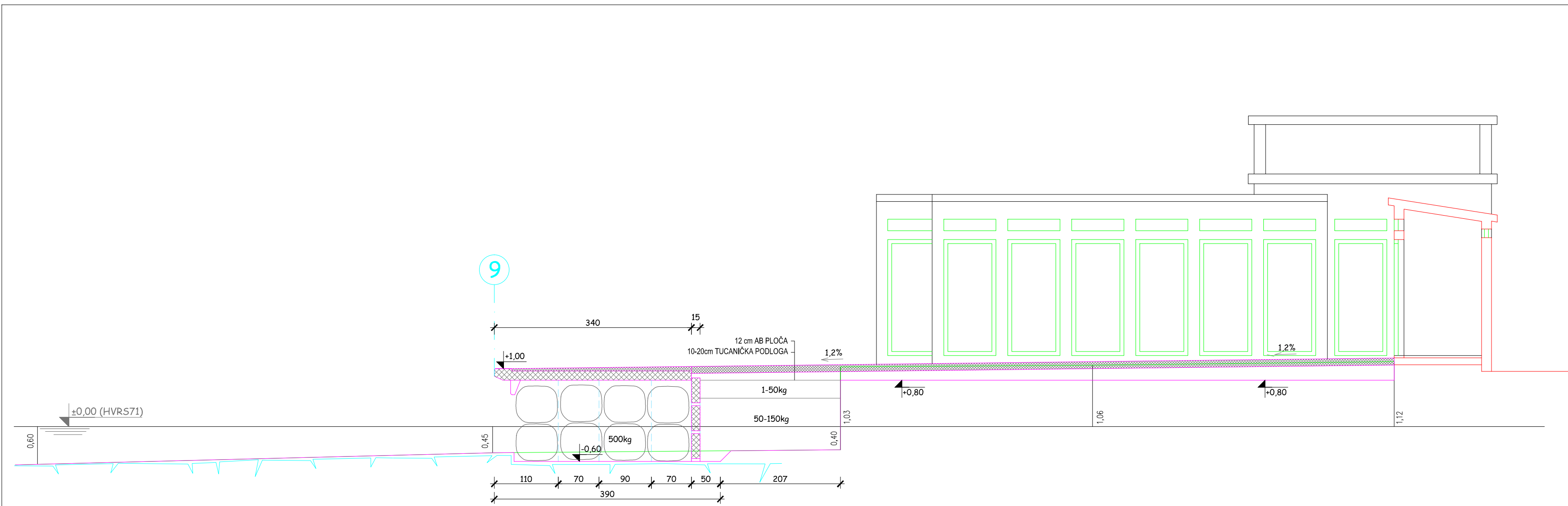

PRESJEK 9

mj 1:50

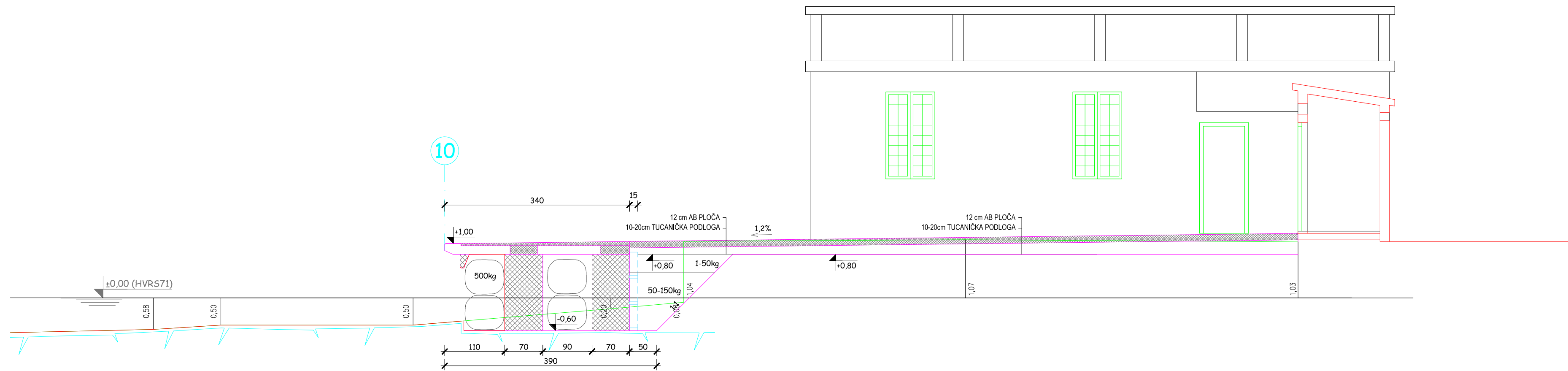

PRESJEK 10

mj 1:50

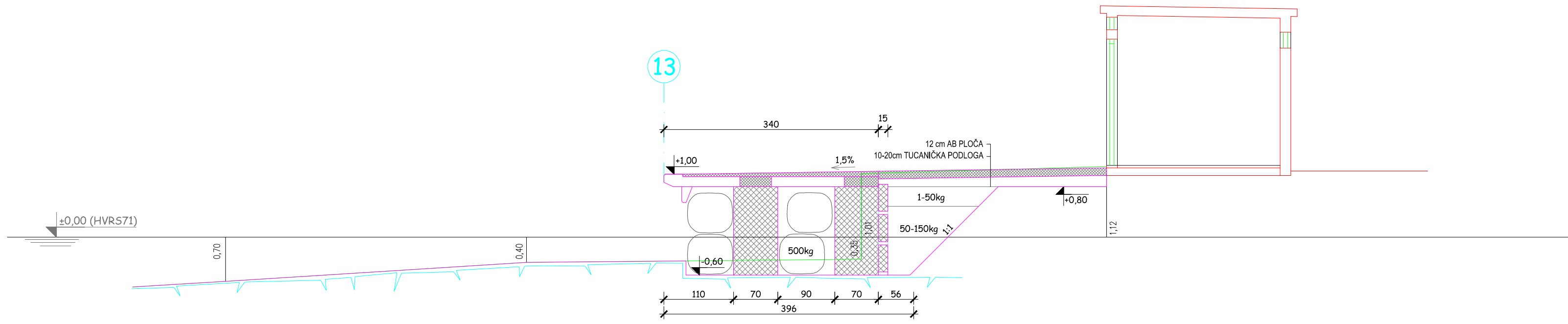

PRESJEK 13

mj 1:50

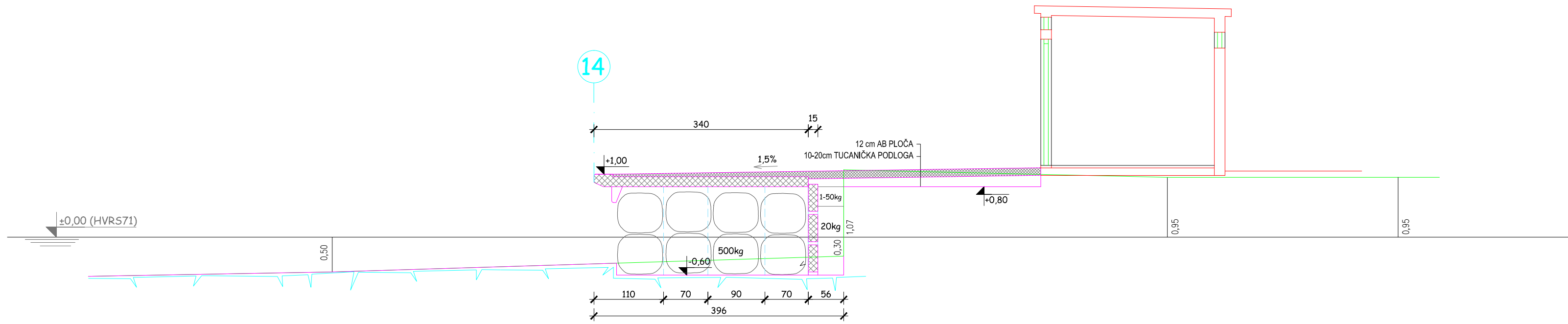

PRESJEK 14

mj 1:50

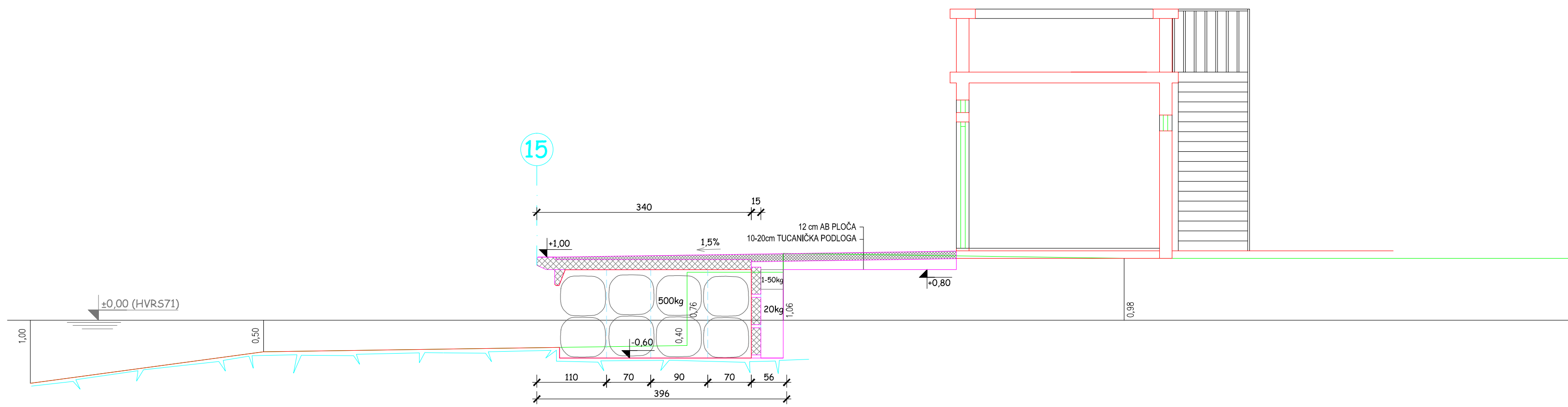

PRESJEK 15

mj 1:50

ISKAZ POVRŠINA GRAĐEVINE**PRIZEMLJE**

Prostorija	Neto površina	Koeficijent	Neto korisna površina	Bruto građevinska površina
Objekt "A1"	28,64 m ²	1,00	28,64 m ²	35,19 m ²
Objekt "A2"	132,80 m ²	1,00	132,80 m ²	160,32 m ²
Objekt "A3"	7,86 m ²	1,00	7,86 m ²	11,56 m ²
Objekt "A4"	7,86 m ²	1,00	7,86 m ²	11,64 m ²
Objekt "A5"	20,25 m ²	1,00	20,25 m ²	28,92 m ²
Objekt "A6"	20,70 m ²	1,00	20,70 m ²	21,03 m ²
Objekt "A7"	44,41 m ²	1,00	44,41 m ²	52,25 m ²
Objekt "A8"	8,16 m ²	1,00	8,16 m ²	11,72 m ²
Objekt "A9"	8,16 m ²	1,00	8,16 m ²	11,39 m ²
Objekt "A10"	10,82 m ²	1,00	10,82 m ²	13,53 m ²
Objekt "A11"	29,26 m ²	1,00	29,26 m ²	42,32 m ²
Objekt "A12"	124,70 m ²	1,00	124,70 m ²	151,22 m ²
Objekt "A13"	28,26 m ²	1,00	28,26 m ²	34,75 m ²
Prolazi između objekata "A1"- "A13"	18,74 m ²	0,25	4,69 m ²	4,69 m ²
Objekt "B1"	50,66 m ²	1,00	50,66 m ²	61,28 m ²
Objekt "B2"	121,60 m ²	1,00	121,60 m ²	146,97 m ²
Objekt "B3"	18,66 m ²	1,00	18,66 m ²	22,96 m ²
Prolazi između objekata "B1"- "B3"	7,45 m ²	0,25	1,86 m ²	1,86 m ²
Objekt "C1"	18,66 m ²	1,00	18,66 m ²	22,96 m ²
Objekt "C2"	66,24 m ²	1,00	66,24 m ²	77,05 m ²
Objekt "C3"	18,66 m ²	1,00	18,66 m ²	22,96 m ²
Prolazi između objekata "C1"- "C3"	1,58 m ²	0,25	0,40 m ²	0,40 m ²
UKUPNO:	794,13 m²		773,30 m²	946,97 m²

PRIZEMLJE NETO POVRŠINA:**794,13 m²****PRIZEMLJE NETO KORISNA POVRŠINA:****773,30 m²****PRIZEMLJE GRAĐEVINSKA BRUTO POVRŠINA:****946,97 m²**

1. KAT (TERASA)

Prostorija	Neto površina	Koeficijent	Neto korisna površina	Bruto građevinska površina
Objekt "A1" nenatkrivena terasa	21,91 m ²	0,25	5,48 m ²	6,40 m ²
Objekt "A1" nenatkrivene stube	6,40 m ²	0,75	4,80 m ²	4,96 m ²
Objekt "A7" nenatkrivena terasa	49,42 m ²	0,25	12,36 m ²	13,85 m ²
Objekt "A7" nenatkrivene stube	6,68 m ²	0,75	5,01 m ²	5,18 m ²
Objekt "A13" nenatkrivena terasa	21,97 m ²	0,25	5,49 m ²	6,41 m ²
Objekt "A13" nenatkrivene stube	6,97 m ²	0,75	5,23 m ²	5,40 m ²
Objekt "B1" nenatkrivena terasa	21,23 m ²	0,25	5,31 m ²	6,25 m ²
Objekt "B1" nenatkrivene stube	6,42 m ²	0,75	4,82 m ²	4,97 m ²
Objekt "B3" nenatkrivena terasa	21,22 m ²	0,25	5,31 m ²	6,25 m ²
Objekt "B3" nenatkrivene stube	5,85 m ²	0,75	4,39 m ²	4,53 m ²
Objekt "C1" nenatkrivena terasa	21,22 m ²	0,25	5,31 m ²	6,25 m ²
Objekt "C1" nenatkrivene stube	5,85 m ²	0,75	4,39 m ²	4,53 m ²
Objekt "C3" nenatkrivena terasa	21,22 m ²	0,25	5,31 m ²	6,25 m ²
Objekt "C3" nenatkrivene stube	5,85 m ²	0,75	4,39 m ²	4,53 m ²
UKUPNO:	222,21 m²		77,56 m²	85,76 m²

1. KAT NETO POVRŠINA:**222,21 m²****1. KAT NETO KORISNA POVRŠINA:****77,56 m²****1. KAT GRAĐEVINSKA BRUTO POVRŠINA:****85,76 m²****REKAPITULACIJA POVRŠINA****NETO POVRŠINA****PRIZEMLJE****794,13 m²****1. KAT****222,21 m²****SVEUKUPNO NETO POVRŠINA:****1016,34 m²****NETO KORISNA POVRŠINA****PRIZEMLJE****773,30 m²****1. KAT****77,56 m²****SVEUKUPNO NETO KORISNA POVRŠINA:****850,87 m²****GRAĐEVINSKA BRUTO POVRŠINA****PRIZEMLJE****946,97 m²****1. KAT****85,76 m²****SVEUKUPNO GRAĐEVINSKA BRUTO POVRŠINA:****1032,73 m²**